

PROPRIETARY INFORMATION:

PROPRIETARY OF GLOBTEK, INC. ANY REPRODUCTION, DISCLOSURE OR USE OF THIS DRAWING, IN WHOLE OR IN PART, IS HEREBY PROHIBITED EXCEPT AS SPECIFIED IN WRITING BY GLOBTEK, INC.

REVISION HISTORY

REV	DESCRIPTION	SALES	RFS	DATE	APPROVED
A	Initial Release	SV	26926	10/11/2017	DR
B	Change 4 digit serial number on the label	SV	26957	11/14/2017	DR
C	Update fuel gauge from BQ20Z70 to BQ40Z50. Update battery dimensions from 65.2*74.0*25mm (Max.) to 67*26.5*76mm(Max.); add 10K NTC	SV	27049	4/3/2017	DR
D	Update label detailing of number starting	SV	27053	4/9/2018	DR
E	Update label detailing of number starting	SV	27073	4/27/2018	DR
F	Added "Caution Statement to page 1	SV	27276	2/14/2019	DR
F	Change max charging voltage from 16.8V to 16.4V; add IEC code to Model No.; Change Charger Input from 16-20VDC to 18-20VDC	SV	27326	5/1/2019	DR
	Change fuel gauge P/N from BQ40Z50 to BQ40Z50-R1.				
G	Rename Section 3 "CHARGER SPECIFICATIONS" to "RECOMMENDED CHARGING SOURCE SPECIFICATIONS"; Rename "CHARGER INPUT" to " CHARGING SOURCE INPUT VOLTAGE"; Rename 'CHARGER INPUT CURRENT" to "CHARGING SOURCE INPUT CURRENT",Change maximum charging voltage from16.4V to16.6V,change Discharge Cut-Off from 11.0V to 11.2V	SV	27483	12/31/2019	DR
H	Add BATTERY STORAGE MAINTENANCE INTERVAL, update packing drawing	DR	27525	6/9/2020	DR
H1	Format update	DR	27537	7/5/2020	DR
H2	Expired certificate IEC62133:2012 (2nd edition)	DR	27725	6/24/2022	DR
I	Update general specification: Cell to LR1865SK, PCM to Globtek Standard, Fuel cuage to BQ40Z50-R2,	DR	27728	6/28/2022	DR
	Nominal voltage to 14.6V, Watt-Hour rating to 37.96WH, recommended charge cui off to by current 0.02C timer 6.5H				
	Charge Retention /Storage, Update label Output to 14.6V, 37.96Wh, Over discharge detection to 0.8 to 1.2 sec				

See Page 2 for important battery warranty and usage information.

Foot Note:

Globtek Inc. will not be liable for the safety and performance of these power supplies if unauthorized access and repair occurs. End user should consult applicable UL, CSA or EN standards for proper installation instruction.

Limitation of Use:

Globtek product are not authorized for use as mission critical components in life support hazardous environment, nuclear or aircraft applications without prior written approval from the CEO of Globtek Inc.

Contents of this document are subject to change without prior notice

 GlobTek®, Inc.
www.globtek.com

186 Veterans Drive, Northvale, NJ 07467
Tel. 201-784-1000 Fax 201-784-0111

Drawing Title: Li-Ion Battery with Fuel Gauge and Built - In Charger

14.8 Volts @ 2600mAh

Model No.: BL2600C18654S1PGQG (4ICR19/65)

Part No.: BL2600C18654S1PGQG

Rev. I

PROPRIETARY INFORMATION:

PROPRIETARY OF GLOBTEK, INC. ANY REPRODUCTION, DISCLOSURE OR USE OF THIS DRAWING, IN WHOLE OR IN PART, IS HEREBY PROHIBITED EXCEPT AS SPECIFIED IN WRITING BY GLOBTEK, INC.

By customer signing or accepting this document, they agree to acknowledge and accept the **Guidelines and cautions, Safety Notes, and Safety Precautions published on GlobTek's website**
http://en.globtek.com/safety-cautions.php#.UUD-NRzU_I8

GlobTek offers a 5-year warranty on workmanship and electrical components assembly on all new battery pack products excluding the battery cells themselves which are covered by the Manufacturer's original warranty at their published warranty period. Please refer to the manufacturer's manufacturer's warranty policy for cells. For GlobTek brand cells, GlobTek provides a 12-month warranty for Li-Ion batteries. The warranty period is based upon the expectation that the battery will deliver 80% of its initial capacity after 300 cycles at low to moderate power loads. High power loads may cause a battery to reach 80% of initial capacity in less than the 12-month warranty period. Li-Ion batteries will continue to operate below the 80% capacity threshold; however, the capacity (run time) delivered between charges will continue to decrease.

The purchaser of GlobTek battery pack products (Customer) agrees that they are a "Sophisticated user" who understands battery technology and that it is their sole responsibility to determine suitability of the product described for their application and to take precaution for protection against any hazards attendant to the handling and use of the product. GlobTek products are only designed for professional use and integration by companies into their products and may not be used by consumers directly. GlobTek provides batteries and battery packs as a component of an end system.

The acceptance of GlobTek specifications, the information on this page and use of the product(s) described in this or other GlobTek documents indicate that the product was qualified for use (tested and/or sample waiver signed), and the acceptance and binding of the customer to GlobTek terms and conditions, which supersede all other agreements, terms and conditions
<http://en.globtek.com/terms-and-conditions/>

Lithium Ion batteries are inherently dangerous. Continuous usage or charging without allowing the battery to discharge is a hazard. FIRE HAZARD: This like all Li-Ion battery packs must be regularly discharged and charged. it is not recommended to be kept on permanent full charge and in a full state of charge.

Customer Approval of Specification:

Please approve, sign and send back to GlobTek so we can complete order processing.

A delay in receipt of this form will delay delivery schedule.

Company Name:

Customer P/N:

Quote Number:

Date:

Authorized Representative Name:

Authorized Representative Signature:

 GlobTek® Inc.

www.globtek.com

186 Veterans Drive, Northvale, NJ 07467

Tel. 201-784-1000 Fax 201-784-0111

Drawing Title: Li-Ion Battery with Fuel Gauge and Built-In Charger

14.8 Volts @ 2600mAh

Model No.: BL2600C18654S1PGQG (4ICR19/65)

Part No: BL2600C18654S1PGQG

Rev. I

PROPRIETARY INFORMATION:

PROPRIETARY OF GLOBTEK, INC. ANY REPRODUCTION, DISCLOSURE OR USE OF THIS DRAWING, IN WHOLE OR IN PART, IS HEREBY PROHIBITED EXCEPT AS SPECIFIED IN WRITING BY GLOBTEK, INC.

1. GENERAL SPECIFICATION:

Battery with safety circuit, charger and fuel gauge:

CELL:	LR1865SK
PCM:	Globtek Standard
NTC:	10K NTC
ID:	N/A
Fuel Gauge	BQ40Z50-R2
Configuration:	4S1P

2. ELECTRICAL SPECIFICATION FOR PACK:

RATED CAPACITY:	2600mAh(Typical); 2500mAh(Min)□
NOMINAL VOLTAGE:	14.6 Volts
WATT-HOUR RATING:	37.96WH
CHARGING METHOD:	Constant Current; Constant Voltage
MAXIMUM CHARGE VOLTAGE [V]:	16.6(±50mV)
CHARGE CURRENT:	1.0A
RECOMMENDED CHARGE CUT OFF:	By current 0.02C or timer 6.5H
MAX. CONTINUOUS DISCHARGE CURRENT:	1.0C
RECOMMENDED DISCHARGE CUT OFF:	11.2(±50mV)
INTERNAL IMPEDANCE:	≤300mΩ
EXPECTED CYCLE LIFE:	>300 cycles > 70% of rated capacity(CC charge 0.5C to 16.8V/Discharge 0.5C to 11.0V)
CELL PROTECTION:	
OVER CHARGE DETECTION:	4.25 ±0.025 volts (0.8 to 1.2 sec. delay, resume 4.10 ±0.05V)
OVER DISCHARGE DETECTION:	2.75 ±0.05 volts (0.8 - 1.2 sec. delay, resume remove load & charging current)
OVER CURRENT DETECTION:	4.0A to 6.0 A (2 sec. delay)

3. RECOMMENDED CHARGING SOURCE SPECIFICATIONS:

CHARGING SOURCE INPUT VOLTAGE:	18-20VDC
CHARGING SOURCE INPUT CURRENT:	2A

4. AMBIENT CONDITIONS

TEMPERATURE RANGE:	
CHARGE:	0 to +45°C
DISCHARGE:	-20 to +60°C
CHARGE RETENTION/STORAGE [%]:	≤1 year -20 to +20°C >80% ≤3 months -20 to +40°C >80% ≤1 month -20 to +60°C >80%
BATTERY STORAGE MAINTENANCE INTERVAL	(FOR BATTERIES STORED AT APPROX. 40% STATE OF CHARGE) Every 3 months @ -20°C TO 25°C Every 1 month @ -20°C TO 60°C
HUMIDITY:	60±25%RH

5. ENVIRONMENTAL AND SAFETY

PLEASE FOLLOW GlobTek, Inc. HANDLING AND SAFETY PRECAUTIONS FOR Lilon & LiPolymer.

6. CELL REGULATORY APPROVALS: CELL APPROVED TO UL 1642



PROPRIETARY INFORMATION:

PROPRIETARY OF GLOBTEK, INC. ANY REPRODUCTION, DISCLOSURE OR USE OF THIS DRAWING, IN WHOLE OR IN PART, IS HEREBY PROHIBITED EXCEPT AS SPECIFIED IN WRITING BY GLOBTEK, INC.

7. BATTERY PACK APPROVALS:

RoHS:	COMPLIES WITH EU 2002/95/EC AND CHINA SJ/T 11363-2006
CE Mark:	COMPLIES WITH 2004/108/EC ELECTROMAGNETIC COMPATIBILITY INCLUDING BUT NOT LIMITED TO EN61000-6-1:2007, EN61000-6-3:2007
TRANSPORTATION:	Pack approved to UN38.3
Safety:	Designed to meet UL2054; IEC 62281

Internal Fuel Gauge with SMBus

Internal Charger for Plug+Play

8. MECHANICAL:

DIMENSIONS:	67.0mm x 76.0 mm x 26.5mm (Max)
SHRINK WRAP:	PVC
WIRE TYPE:	UL1007 20AWG
WIRE LENGTH:	50mm ± 5.0 mm
P1 WIRE POLARITY:	Vin + (Red)
P2 WIRE POLARITY:	DC Common (Black)
P3 WIRE POLARITY:	SMBC (Clock Data) (Yellow)
P4 WIRE POLARITY:	SMBD (Data Line) (Green)
P5 WIRE POLARITY:	BAT + (Red)
L6 WIRE POLARITY:	DC Common (Black)
CONNECTOR TYPE:	Molex 43025-0600
STRIP LENGTH:	N/A
TIN LENGTH:	N/A
ADDITIONAL REQUIREMENTS:	N/A

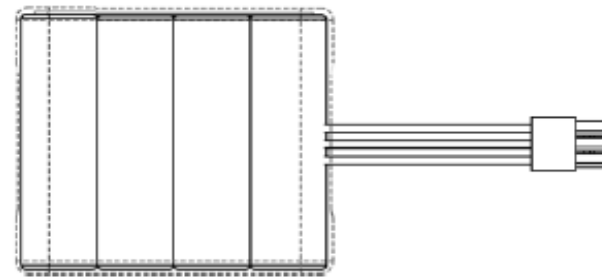
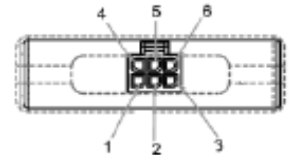
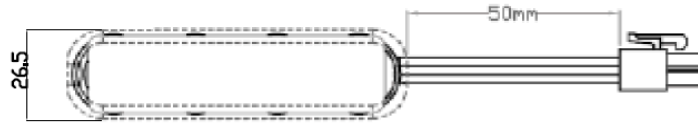
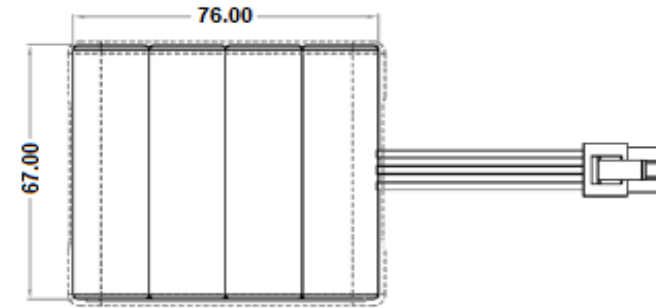
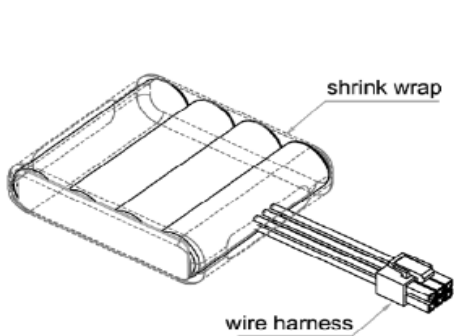

[ADDITIONAL OUTPUT PLUG OPTIONS ARE AVAILABLE BY CLICKING THIS LINK.](#)
[STANDARD PLUGS AND CONNECTORS CAN BE SEEN ONLINE BY CLICKING THIS LINK](#)

PROPRIETARY INFORMATION:

PROPRIETARY OF GLOBTEK, INC. ANY REPRODUCTION, DISCLOSURE OR USE OF THIS DRAWING, IN WHOLE OR IN PART, IS HEREBY PROHIBITED EXCEPT AS SPECIFIED IN WRITING BY GLOBTEK, INC.

9.CONNECTOR:

ACTUAL CONNECTOR'S, OVERMOLDS, MAY VARY SLIGHTLY FROM THE PICTURE BELOW

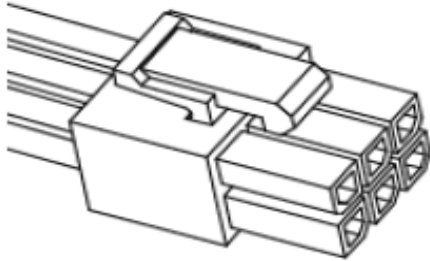

	EQUIVALENT	Y / N	
PLUG TYPE		Y	MOLEX 43025-0600
HOUSING TYPE			FEMALE
TERMINALS		Y	MOLEX 43030-0001
TERMINAL TYPE			FEMALE
OVER MOLD ORIENTATION			N/A
PLUG DIMENSIONS			N/A
BARREL PLUG INTERNAL SPRING CLIP			N/A
BARREL PLUG LOCKING NOTCH			N/A
POLARITY			N/A
ADDITIONAL REQUIREMENTS			N/A

[ADDITIONAL OUTPUT PLUG OPTIONS ARE AVAILABLE BY CLICKING THIS LINK.](#)
[STANDARD PLUGS AND CONNECTORS CAN BE SEEN ONLINE BY CLICKING THIS LINK](#)

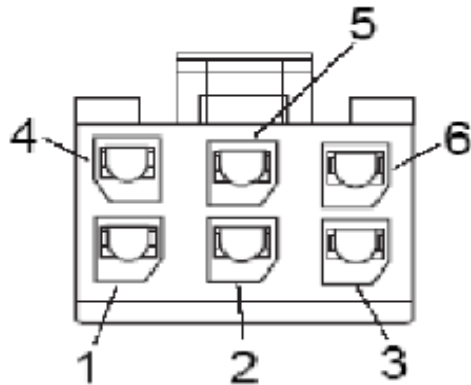

Internal Fuel Gauge with SMBus

Internal Charger for Plug+Play

PROPRIETARY INFORMATION:

PROPRIETARY OF GLOBTEK, INC. ANY REPRODUCTION, DISCLOSURE OR USE OF THIS DRAWING, IN WHOLE OR IN PART, IS HEREBY PROHIBITED EXCEPT AS SPECIFIED IN WRITING BY GLOBTEK, INC.

10. LABEL:

MATERIAL:	Flat thermal transfer polyester sheet
BACKGROUND COLOR:	WHITE or SILVER
TEXT COLOR:	BLACK
LABEL WIDTH: (mm)	60±5mm
LABEL HEIGHT: (mm)	45±5mm
ADDITIONAL REQUIREMENTS:	N/A
ADDITIONAL REQUIREMENTS:	N/A

**Internal Fuel
Gauge with
SMBus**

**Internal
Charger for
Plug+Play**

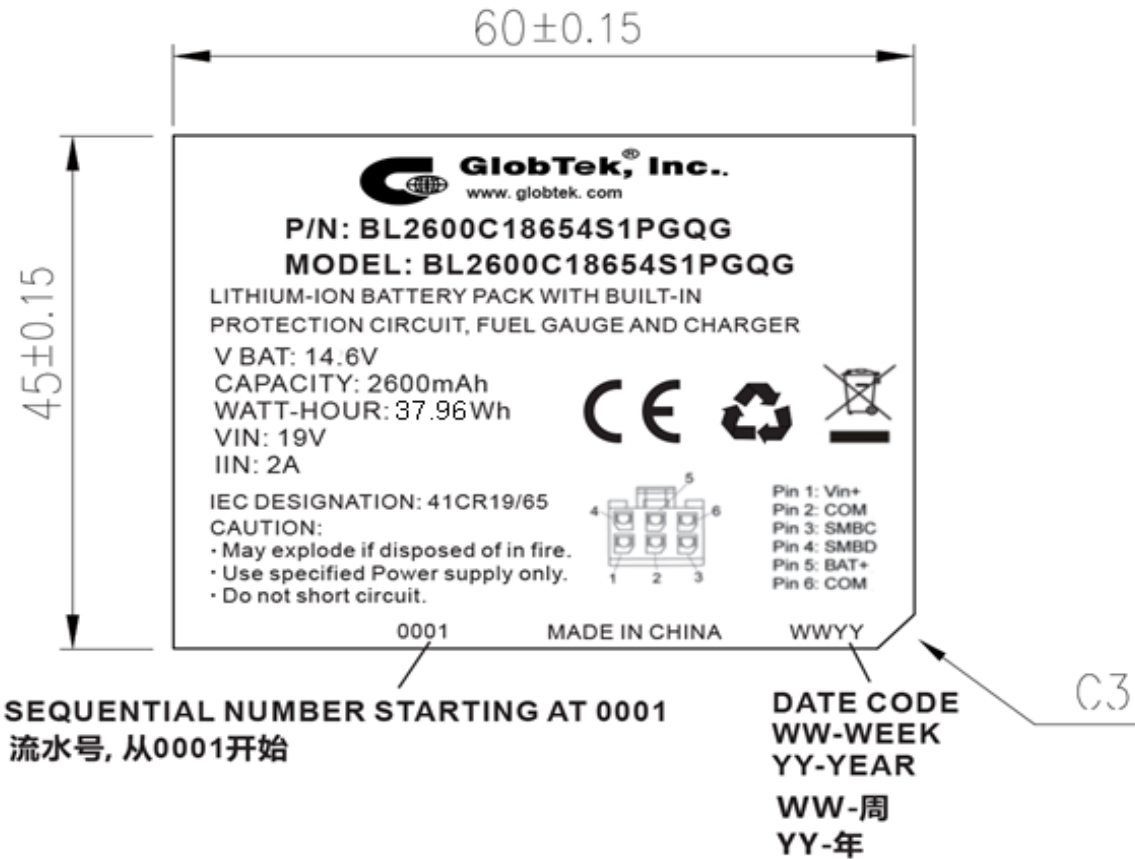

PROPRIETARY INFORMATION:

PROPRIETARY OF GLOBTEK, INC. ANY REPRODUCTION, DISCLOSURE OR USE OF THIS DRAWING, IN WHOLE OR IN PART, IS HEREBY PROHIBITED EXCEPT AS SPECIFIED IN WRITING BY GLOBTEK, INC.

11. PACKAGING:

PE BAG SIZE	TBD
CARTON SIZE:	TBD
QUANTITY PER CARTON:	TBD
G.W.	TBD

