



ISO 9001:2000
REGISTERED



**15 Watts, Wall Plug-In, Switchmode Power Supply, N.A.,
European, U.K., SAA Universal Input, ITE, Class II**

Part Number Ordering System (See Page 224)
Output Plug/Cord Options (See Page 189)



ELECTRICAL SPECIFICATIONS

INPUT VOLTAGE:
100-240 VAC

INPUT CURRENT:
< 0.6 A RMS MAX

INPUT FREQUENCY:
47 - 63 HZ

OUTPUT CURRENT:
NO LOAD TO FULL LOAD, NO MINIMUM LOAD REQUIRED

OUTPUT POWER (RATED):
15 WATTS MAX

OUTPUT RIPPLE (PEAK TO PEAK):
100 mV

OUTPUT REGULATION (LINE/LOAD):
± 5 % FOR MAIN OUTPUT, MEASURED AT O/P CONNECTOR

LINE REGULATION:
± 1 % MAX AT FULL LOAD

TURN ON/ TURN OFF OVERSHOOT:
4% MAX 500µS MAX RECOVERY TIME FOR 25% STEP LOAD

TURN-ON DELAY:
3000 mSEC MAX

HOLD-UP TIME:
16 m SEC MIN AT NOMINAL INPUT AND FULL LOAD

INRUSH CURRENT:
30 A MAX AT COLD START 120 VAC, 60A MAX COLD START 230VAC

SWITCHING FREQUENCY:
66.5 KHz TYPICAL

OVER-VOLTAGE PROTECTION:
VOLTAGE LIMITED LESS 130% OF NOMINAL VOLTAGE

OVER-CURRENT / SHORT CIRCUIT:
HICCUP WITH AUTO RECOVERY TO 1.1 - 1.3 I_o

OTHER PROTECTION:
INPUT FUSING

SAFETY APPROVALS:
UL60950, CUL TO 22.2# 950, DEMKO TO EN60950-12001, AS/NZ 60950-1 CCC TO GB4943-2001, GB9254-1998, GB17625.1-2003, CE CLASS II, PSE TO J60950, AS/NZ 60950, CB REPORT, ARGENTINA S-MARK TO IEC 60950-1: 10/2001, TAIWAN BSMI TO CNS14336 (12v), SINGAPORE SPRING TO IEC60950-1:2001, VCCI

DIELECTRIC WITHSTAND VOLTAGE:
3000VAC PRIMARY-SECONDARY

LEAKAGE CURRENT:

≤ 0.25 mA

LINE SURGE:
EN 61000-4-5 LEVEL 4

EMI:
COMPLIES WITH EN55022 CLASS B AND FCC PART 15 CLASS B WHEN TESTED WITH A RESISTIVE LOAD, BOTH CONDUCTED AND RADIATED.

CE MARK:
TESTED TO COMPLY WITH EN61000-3-2 EN61000-3-3 AND EN50082-1, INCLUDING EN61000-4-2, EN61000-4-3, EN61000-4-4, EN61000-4-5, EN61000-4-6, EN61000-4-11, LEVEL 4. UNIT IS ELIGIBLE FOR CE MARK.

C-TICK:
TESTED TO COMPLY WITH RADIO TELECOMMUNICATIONS ACT OF 1992

MTBF:
GREATER THAN 200,000 HOURS AT 25°C AMBIENT TEMPERATURE

AMBIENT TEMPERATURE, OPERATING TEMPERATURE:
0° C TO 40° C

STORAGE TEMPERATURE:
-40° C TO 80° C

HUMIDITY:
0% TO 90% RELATIVE HUMIDITY

MODEL NUMBER DESCRIPTION:
MODEL GT-41052-WWVV-X.X
WHERE:
41052: SERIES CODE
WW = DENOTES RATED WATTAGE
(VV) = RATED VOLTAGE
(X.X) = DENOTES VOLTAGE DIFFERENTIATOR

PART NUMBER DESIGNATION:
SEE P/N SYSTEM FOR EXPLANATION:
XXX - DESIGNATION OUTPUT CORD + PLUG OPTION

NOTES:

1. EACH OUTPUT CURRENT MAY VARY WITHIN IT'S DESIGNATION RANGE, AS LONG AS OUTPUT POWER IS NOT EXCEEDED.
2. SINGLE OUTPUT MAY VARY FROM 5VDC-24VDC IN 0.1V INCREMENTS
3. (-.Y.Y) OPTIONAL FOR SPECIFYING OUTPUT VOLTAGE DEVIATION FROM LISTED RATINGS. SUBTRACT Y.Y FROM RATED VOLTAGE.

**OUTPUT VOLTAGE / CURRENT:
NORTH AMERICAN BLADE CONFIGURATION**

MODEL NUMBER	OUTPUT VOLTAGE (VDC)	OUTPUT CURRENT (A)	RATED OUTPUT POWER (W)
GT-41052-1305	+ 5.0	0 - 2.6	15
GT-41052-1506-X.X	+ 6.0	0 - 2.5	15
GT-41052-1507-X.X	+ 7.0	0 - 2.14	15
GT-41052-1509-X.X	+ 9.0	0 - 1.7	15
GT-41052-1512-X.X	+ 12.0	0 - 1.25	15
GT-41052-1512-1.2	+ 13.8	0 - 1.1	15
GT-41052-1515-X.X	+ 15.0	0 - 1.0	15
GT-41052-1518-X.X	+ 18.0	0 - 0.84	15
GT-41052-1520-X.X	+ 20.0	0 - 0.75	15
GT-41052-1524-X.X	+ 24.0	0 - 0.63	15
GT-41052-1548-22.0	+ 36.0	0 - 0.41	15
GT-41052-1548	+ 48.0	0 - 0.31	15

SPECIFICATIONS MAY CHANGE WITHOUT PRIOR NOTICE. CONSULT GLOBTEK CUSTOMER SERVICE FOR LATEST SPECIFICATIONS.



15 Watts, Wall Plug-In, Switchmode Power Supply, N.A., European, U.K., SAA Universal Input, ITE, Class II

Part Number Ordering System (See Page 224)
Output Plug/Cord Options (See Page 189)



ENCLOSURES

HOUSING: HIGH IMPACT PLASTIC, 94V0 POLYCARBONATE, NON-VENTED, COLOR BLACK, COLOR BLACK, CUSTOMER SPECIFIED COLOR AVAILABLE UPON REQUEST.

STANDARD OPTION SHIPS WITHOUT AC PINS INSTALLED

SIZE:
74 x 43.5 x 34 mm

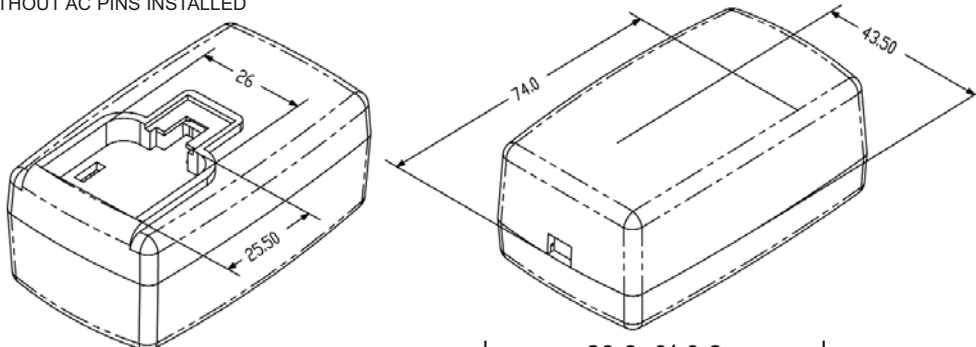

STANDARD OPTION, PINS TO BE ORDERED SEPARATELY

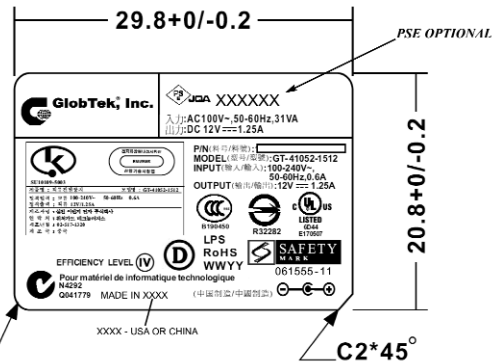

- INPUT CONNECTOR:**
N.A. CONFIGURATION:
1. CLASS II MODEL NEMA 1-15P JIS AC POWER RECEPTACLE WITH 2 PRONGS
2. AUSTRALIAN CONFIGURATION:
AS/NZ 3112 2 PINS CLASS II
3. UK CONFIGURATION:
BS 1363 2 PINS CLASS II
4. EUROPEAN CONFIGURATION:
EUROPLUG CEE 7/16 2 PINS, CLASS II

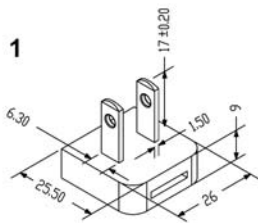

P/N: Q-NA
NORTH AMERICA
JAPAN
CHINA

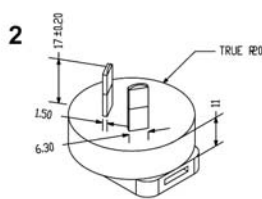

P/N: Q-SAA
AUSTRALIA
CHINA

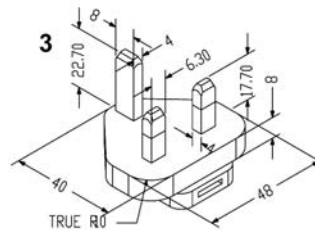

P/N: Q-UK
UNITED KINGDOM
HONG KONG
SINGAPORE

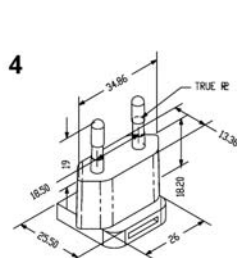

P/N: Q-EU
EUROPE
SOUTH AMERICA

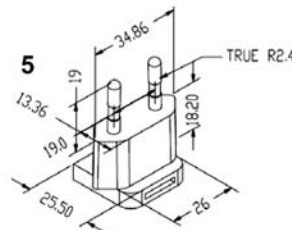

P/N: Q-KR
KOREA

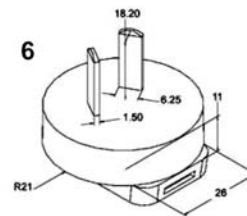

P/N: Q-AR
ARGENTINA

