

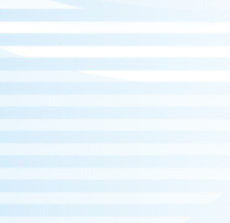

**Switcher, 200 Watt, Family, Single Output,
Open Frame Universal Input, Medical, Class I**

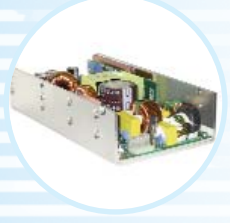

ELECTRICAL SPECIFICATIONS:

INPUT RANGE:

90-264 VAC

INPUT LINE FREQUENCY:

47-63Hz

INPUT CURRENT:

<3.2A RMS @ 90VAC

INRUSH CURRENT:

40A TYPICAL, COLD START @ 25°C

EFFICIENCY:

80% TYPICAL AT FULL LOAD

POWER FACTOR:

0.99 TYPICAL

TURN-ON DELAY:

2 SECOND TYPICAL @ 115VAC NOMINAL LINE

INPUT LINE PROTECTION:

MOV TRANSIENT PROTECTED. INPUT LINE FUSE PROVIDED ON-BOARD

SOFT START:

STANDARD ON ALL MODELS

MAXIMUM POWER:

200 WATTS WITH FREE AIR CONVECTION COOLING

ADJUSTMENT RANGE:

± 10%

LOAD REGULATION:

± 2% MEASURED AT THE CONNECTOR SIDE

LINE REGULATION:

± 0.5% MEASURED AT THE CONNECTOR SIDE

HIGH FREQUENCY RIPPLE:

1% OF OUTPUT VOLTAGE, PEAK TO PEAK

TURN ON/OFF OVERSHOOT:

5% MAXIMUM, 1mS RECOVERY TIME

HOLD-UP TIME:

20 mS @ 200W LOAD, 115VAC NOMINAL LINE

TRANSIENT RESPONSE:

1mS RECOVERY TO WITHIN 1% OF THE REGULATION BAND WITH NO MORE THAN 5% OUTPUT VOLTAGE DEVIATION @ 50% LOAD STEP.

OVERLOAD PROTECTION:

PROTECTED @ 115-130% OF FULL LOAD RATING FOLD BACK

SHORT CIRCUIT:

FOLDBACK, AUTORECOVER UPON REMOVAL OF SHORT

OVERVOLTAGE:

10% TO 20% ABOVE NOMINAL OUTPUT, LATCH

INDICATOR:

GREEN LED FOR OUTPUT PRESENCE

FAN OUTPUT:

12V @ 0.15A (UNREGULATED)

MODEL DESCRIPTION:

GTM9200P1323.3-X.X TO 20048-X.X

GT: GLOBTEK SERIES

M: MEDICAL GRADE

9200: FAMILY DESIGNATOR

1323.3 TO 20048: 132W 3.3V TO 200W 48V OUTPUT

POWER OUTPUT VOLTAGE

X.X: OUTPUT VOLTAGE DEVIATION FROM STANDARD MODEL BY SUBTRACTING X.X VOLT FROM STANDARD OUTPUT VOLTAGE.

S: INPUT HEADER AND OUTPUT METAL TERMINAL ON BOARD.

R: IEC INPUT RECEPTACLE AND OUTPUT METAL TERMINAL ON BOARD.

HIOXXX: INPUT AND OUTPUT WIRE HARNESS. WHERE XXX CAN BE FROM 000 TO 999 (MAXIMUM LENGTH FOR INPUT IS 100MM AND 200MM FOR OUTPUT).

HORXXX: IEC INPUT RECEPTACLE ON BOARD AND OUTPUT WIRE HARNESS. WHERE XXX CAN BE FROM 000 TO 999 (MAXIMUM WIRE LENGTH FOR OUTPUT IS 200MM).

HOXXX: INPUT HEADER ON BOARD AND OUTPUT WIRE HARNESS. WHERE XXX CAN BE FROM 000 TO 999 (MAXIMUM WIRE LENGTH FOR OUTPUT IS 200MM).

HIXXX: INPUT WIRE HARNESS. OUTPUT METAL TERMINAL ON BOARD. WHERE XXX CAN BE FROM 000 TO 999 (MAXIMUM WIRE LENGTH FOR INPUT IS 100MM).

HIXXX: INPUT WIRE HARNESS. OUTPUT METAL TERMINAL ON BOARD. WHERE XXX CAN BE FROM 000 TO 999 (MAXIMUM WIRE LENGTH FOR INPUT IS 100MM).

REMOTE ON/OFF:

OPEN, INHIBITS OUTPUT.

DC POWER GOOD:

TTL LOGIC GOES HIGH AFTER THE OUTPUT IS IN REGULATION. IT GOES LOW WHEN THERE IS LOSS OF REGULATION.

REMOTE SENSE:

COMPENSATE FOR 0.5V LEAD DROP. WILL OPERATE WITHOUT REMOTE SENSE CONNECTION.

TEMPERATURE COEFFICIENT:

± 0.02% PER °C, TYPICAL

OPERATING TEMPERATURE:

0° TO 50°C FOR MODELS WITH OUTPUT <12V

0° TO 60°C FOR MODELS WITH OUTPUT ≥12V

STORAGE TEMPERATURE:

-40° TO 85°C

RELATIVE HUMIDITY:

OPERATING; 0-90% NON-CONDENSING

ALTITUDE:

UP TO 10000 FEET

RANDOM VIBRATION/TRANSIENT DROP:

MIL-STD 810E

MTBF:

>200,000 HOURS @ 25° AMBIENT TEMPERATURE, FULL LOAD, NOMINAL LINE, MIL-217 STD.

SAFETY:

HIPOT (PRI-SEC)

5656 VDC

EARTH LEAKAGE:

< 0.3mA @ 50/60Hz, 264 VAC INPUT

APPROVAL:

UL60601-1, CUL TO 22.2 NO. 60601-1, CB REPORT, DEMKO TO EN60601-1.

EMI:

EN55022 CLASS B AND FCC PART 15, TESTED WITH RESISTIVE LOAD.

CE MARK:

EN61000-3-2, EN61000-3-3 AND EN50082-1, INCLUDING EN61000-4-2 (SYSTEM LEVEL), EN61000-4-3, EN61000-4-4, EN61000-4-5, EN61000-4-6, EN61000-4-11 LEVEL 4

NOTES:

1. MEDICAL VERSION IS DESIGNED NOT TO BE USED IN SYSTEM WITH DIRECT PATIENT CONTACT.
2. ALL MEASUREMENTS ARE MADE DIRECTLY AT THE TERMINALS OF THE SUPPLY.
3. OUTPUT RIPPLE AND SPIKE ARE MEASURED DIRECTLY AT THE OUTPUT TERMINALS OF THE POWER SUPPLY WITH 10µF TANTALUM AND 0.1µF CERAMIC CAPACITORS CONNECTED IN PARALLEL. PEAK-TO-PEAK METERING EQUIPMENT MUST HAVE A 20 MHz FREQUENCY RESPONSE WITH PROBES AND CABLES THAT MAINTAIN A FREQUENCY RESPONSE OF 20Hz TO 20MHz. OUTPUT RIPPLE SPECS OF 3.3V AND 5V MODELS IS 2% OF RESPECTIVE OUTPUT VOLTAGE.
4. CONDUCTED AND RADIATED EMI WERE PERFORMED WITH RESISTIVE LOAD SET TO FULL. PSU AND RESISTIVE LOAD WERE MOUNTED TOGETHER IN A 30 x 30 x 3 mm ALUMINUM PLATE.
5. REMOTE SENSE WIRE SHOULD BE TWISTED TOGETHER WHEN USED.
6. ALL MEASUREMENTS ARE MADE AT 25°C AMBIENT TEMPERATURE AND ARE TYPICAL.
7. MOUNTING MAXIMUM INSERTION DEPTH IS 3MM.
8. GLOBTEK PRODUCTS ARE NOT AUTHORIZED TO BE USED AS MISSION CRITICAL COMPONENTS WITHOUT PRIOR WRITTEN APPROVAL FROM THE CEO OF GLOBTEK INC.
9. SPECIFICATIONS ARE SUBJECT TO CHANGE WITHOUT PRIOR NOTICE.



**Switcher, 200 Watt, Family, Single Output,
Open Frame Universal Input, Medical, Class I**

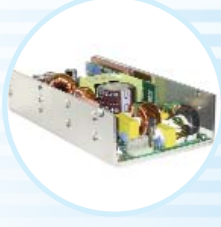
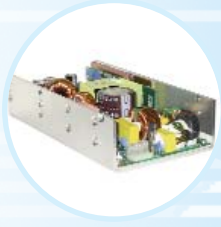

**OUTPUT VOLTAGE / CURRENT:
200 WATTS MODELS, NATURAL CONVECTION**

MODEL NUMBER		OUTPUT VOLTAGE (VDC)	OUTPUT CURRENT (A)	RATED OUTPUT POWER (W)
GTM9200P1323.3-X.X	[S or R or HIOXXX or HORXXX or HOXXX or HIXXX]	+3.30	0 - 40.00	0 - 132
GTM9200P2005-X.X	[S or R or HIOXXX or HORXXX or HOXXX or HIXXX]	+5.00	0 - 40.00	0 - 200
GTM9200P2007.5-X.X	[S or R or HIOXXX or HORXXX or HOXXX or HIXXX]	+7.50	0 - 26.67	0 - 200
GTM9200P2009-X.X	[S or R or HIOXXX or HORXXX or HOXXX or HIXXX]	+9.00	0 - 22.22	0 - 200
GTM9200P20012-X.X	[S or R or HIOXXX or HORXXX or HOXXX or HIXXX]	+12.00	0 - 16.67	0 - 200
GTM9200P20015-X.X	[S or R or HIOXXX or HORXXX or HOXXX or HIXXX]	+15.00	0 - 13.33	0 - 200
GTM9200P20018-X.X	[S or R or HIOXXX or HORXXX or HOXXX or HIXXX]	+18.00	0 - 11.11	0 - 200
GTM9200P20024-X.X	[S or R or HIOXXX or HORXXX or HOXXX or HIXXX]	+24.00	0 - 8.33	0 - 200
GTM9200P20036-X.X	[S or R or HIOXXX or HORXXX or HOXXX or HIXXX]	+36.00	0 - 5.55	0 - 200
GTM9200P20048-X.X	[S or R or HIOXXX or HORXXX or HOXXX or HIXXX]	+48.00	0 - 4.17	0 - 200

OUTPUT DERATING

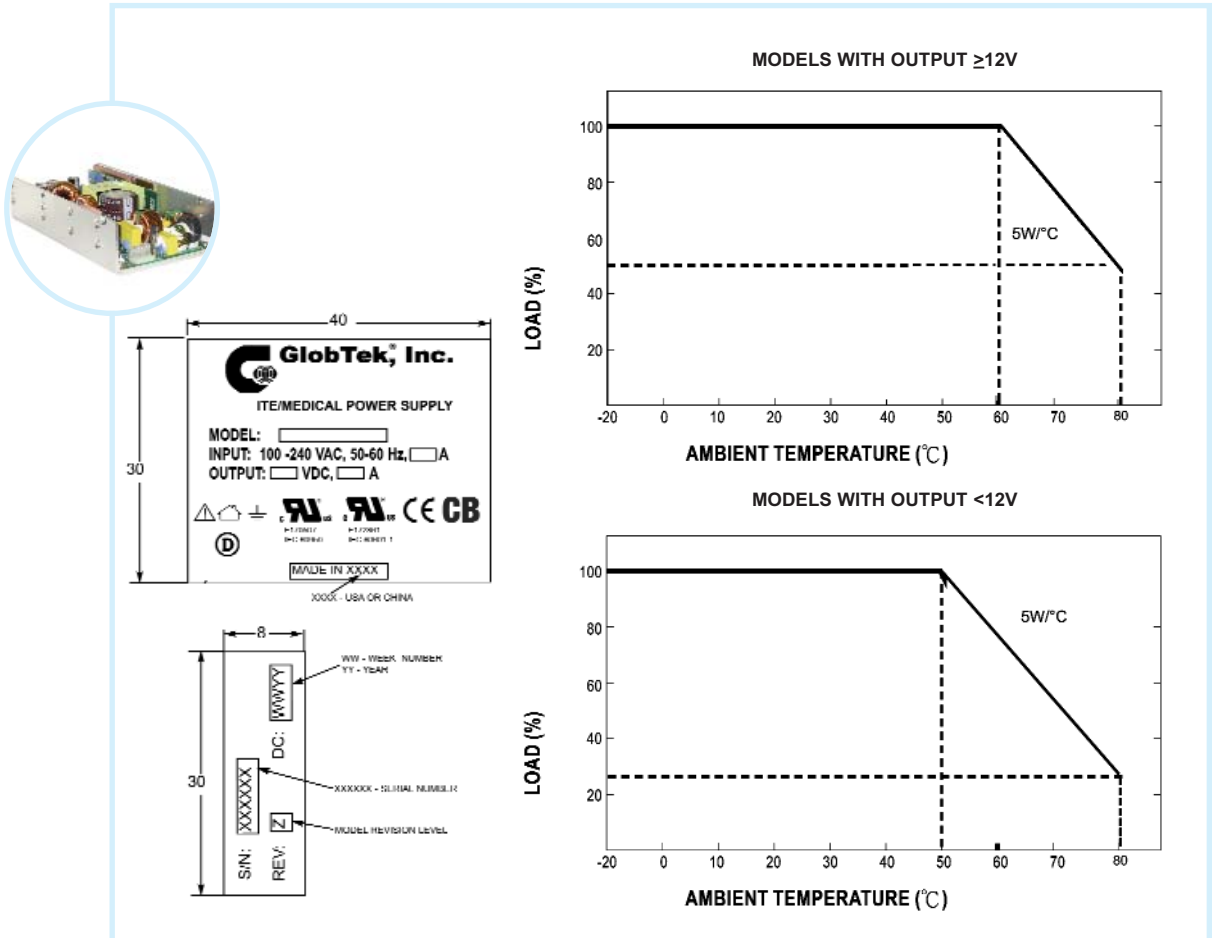

SPECIFICATIONS MAY CHANGE WITHOUT PRIOR NOTICE. CONSULT GLOBTEK CUSTOMER SERVICE FOR LATEST SPECIFICATIONS.

**Switcher, 200 Watt, Family, Single Output,
Open Frame Universal Input, Medical, Class I**



MECHANICAL SPECIFICATION

SIZE: 198.40 x 107.20 x 46.50 mm

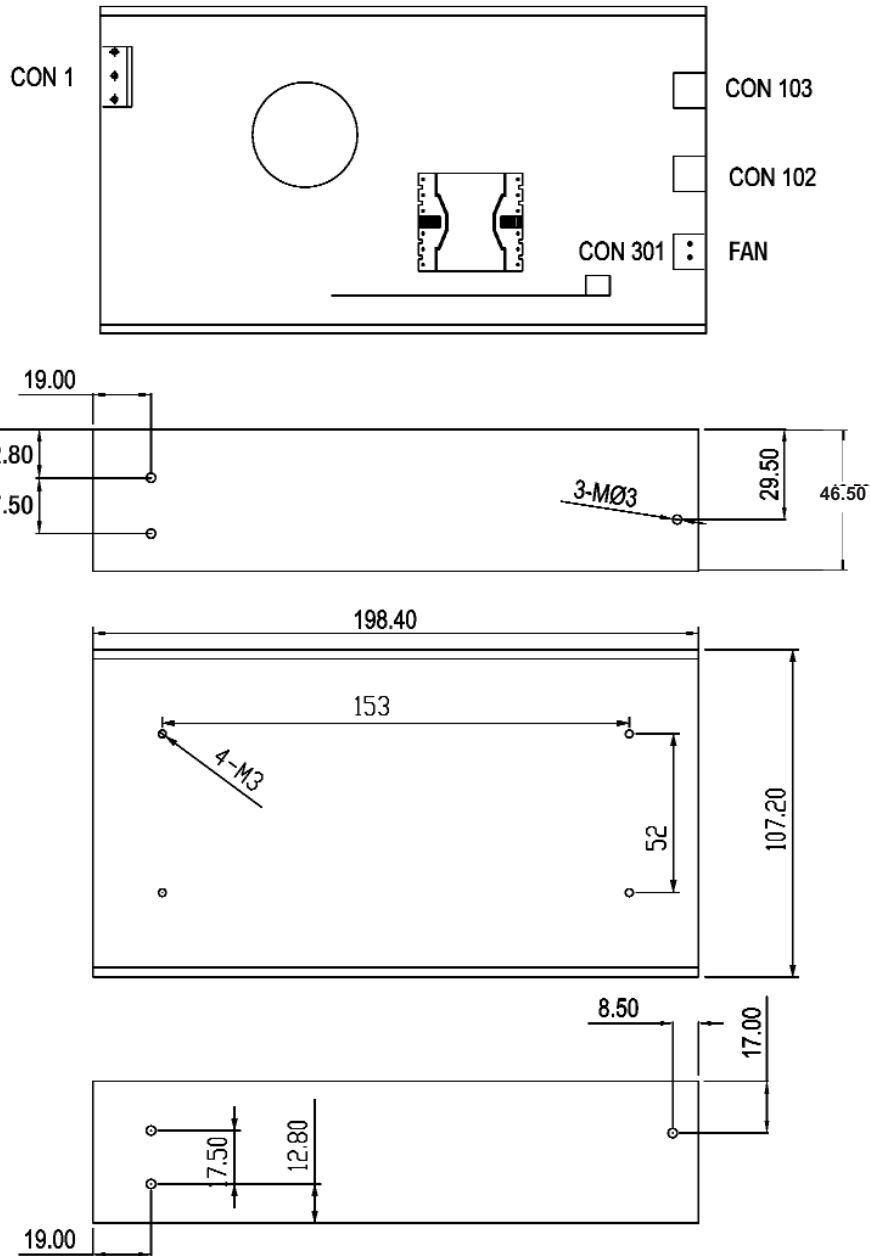
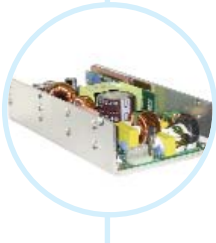

PIN ASSIGNMENTS:
 CON1: (PIN 1: EARTH,
 PIN 3: LIVE, PIN 5: NEUTRAL)
 MOLEX P/N 26-62-4051
 (FOR S and HOXXX versions)
 MOLEX P/N 09-50-3051, CRIMP
 TERMINAL P/N 08-52-0071 (FOR
 HIXXX and HIOXXX versions)
 INALWAYS P/N 0707-1
 (FOR VERSIONS R and HORXXX)
 CON102 (POSITIVE),
 CON103 (COMMON):
 M4X6 SCREW TERMINAL
 (FOR S, R and HIXXX versions)
 MOLEX P/N 39-01-2165 (FOR
 HIOXXX, HIXXX, HOXXX and
 HORXXX versions)
MATING CONNECTORS:
 CON1:
 MOLEX P/N 09-50-3051, CRIMP
 TERMINAL P/N 08-52-0071
 (FOR VERSIONS S and HOXXX)
 MOLEX P/N 26-62-4051
 (FOR VERSIONS HIXXX and
 HIOXXX)
 CON102 / CON103:
 MOLEX P/N 39-28-8160, CRIMP
 TERMINAL P/N 44485-1211
 (FOR VERSIONS HIOXXX, HIXXX,
 HOXXX and HORXXX)



SPECIFICATIONS MAY CHANGE WITHOUT PRIOR NOTICE. CONSULT GLOBTEK CUSTOMER SERVICE FOR LATEST SPECIFICATIONS.